

# Effect of Thermal barrier coating with different Thickness in Piston to enhance Temperature distribution

Sujeet Kumar<sup>1</sup>, Anurag Bagri<sup>2</sup>, Vinay Kumar Yadav<sup>3</sup>  
M.Tech Scholar<sup>1</sup>, Assistant Professor<sup>2</sup>, Associate Professor<sup>3</sup>  
Rabindranath Tagore University, Madhya Pradesh, India

## Abstract

In the current work, the CAD model of piston has been developed by using ANSYS design modeler. The model has been simulated using ANSYS software on steady state thermal and static structural domain 15.0 workbench in order to observe various parameters effecting the temperature distribution between different thickness of thermal barrier coating. Four types of configurations of coating thickness were used i.e. 0.5, 0.7, 0.9, 1.2 mm. An optimized model of piston has been developed as stated configurations of coated piston. The simulations have been performed at a standard temperature that is the temperature generated during working of internal combustion engine. The simulation of the optimized model gives lower value of temperature distribution, thermal stress and deformation. The results are validated with reported existing previous work. The configuration of thickness between 0.7 to 0.9 of thermal barrier coating coated with sodium stannate material exhibits higher

temperature distribution compared to titanium dioxide, zirconium and Al - Si.

Key Words – Piston, Temperature distribution, Thermal stress, Deformation, outlet port sodium stannate, titanium dioxide, zirconium and Al – Si, ANSYS, CAD, Simulation.

## 1.1 Overview of my work

In present research work the temperature effects in piston is improved by different thermal barrier coatings with thickness, also observations were made in favor of thermal stress and deformation using finite element method. The simulation was performed in ANSYS package in coupled analysis of steady state thermal and static structural domain to predict the effect of temperature distribution and stresses.

## 1.2 Function of piston

A piston is a moving disk enclosed of a cylinder as is made gas-tight by means of piston rings. The disk moves inner the pipe as like a liquid then fuel inward the barrel expands yet contracts. A piston aids within

the change regarding heat electricity in mechanical work yet stigma versa. Because of this, pistons are an authorization element concerning heat engines. [2] Pistons work by way of transferring the force outturn about an expanding gas between the tubes in accordance with a crankshaft, which gives rotational pace to a flywheel. Such a dictation is recognised as much a reciprocating engine. A piston must follow a cyclical technique between order because of such according to continually alter heat power to work, and at that place are dense methods according to whole that cycle.

### **1.3 OBJECTIVE & PROBLEM FORMULATION**

#### **Objective of present work**

- The main objective of the proposed research work is to validate the FEM analysis of simulations result of different configurations of piston models by comparing the results of research reported in the literature.
- To optimize the different configurations of piston models with thickness ranging between 0.5 – 1.2 mm.

- To analyze the performance parameters temperature distribution of piston models.
- To predict the temperature distribution, thermal stress and deformation on optimized piston along the influences of different thermal barrier coating thickness.
- The major objective of present work is to investigate the temperature distribution of piston with different coating thickness.

#### **Problem Formulation**

The survey of different previous works we predict the temperature is minimum as compared to present study is shown in our base paper. The purposes of this study enhance the temperature distribution and decrease the thermal stress and deformation with different thickness of thermal barrier coating.

### **1.4 RESULTS**

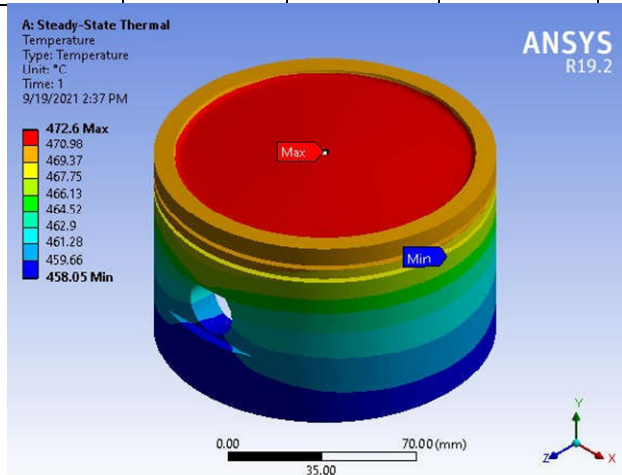
#### **Validation:**

The effects of different thickness of coating in piston and characteristics for temperature, thermal stress and deformation are presented below. The results have been compared with previous research work present in literature

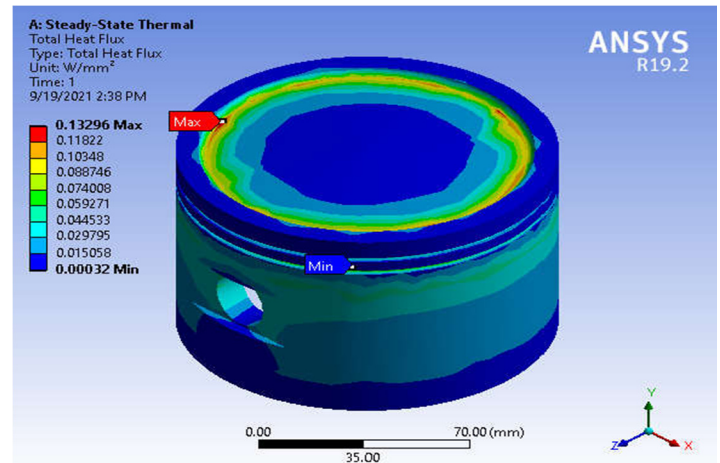
of same parameter and also compare with numerical model developed in present analysis operating under similar operating conditions to discuss the enhancement in temperature distribution of piston with different thickness coatings.

**Table 1.1** Validation of results obtained for uncoated piston.

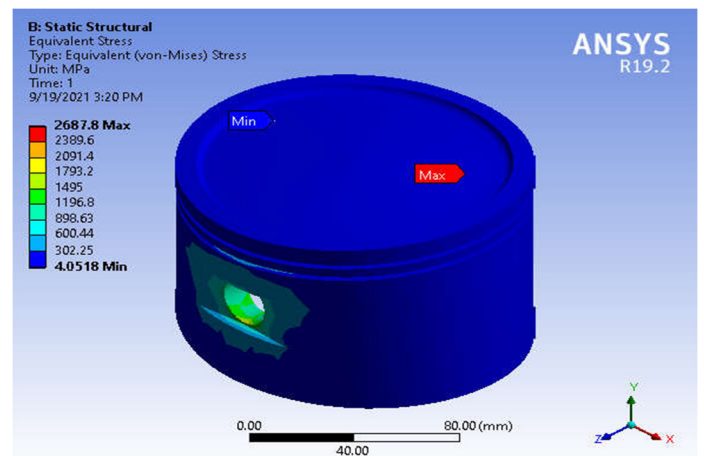
Validation			
Thickn ess (mm)	Tempera ture (degree celcius) (Validati on)	Stress (Mpa) (Validati on)	Deforma tion (mm) (Validati on)
0.5	496	2866.7	1.54
0.7	486	2696.5	1.48
0.9	479.6	2458.2	1.39
1.2	474.3	2245.9	1.32



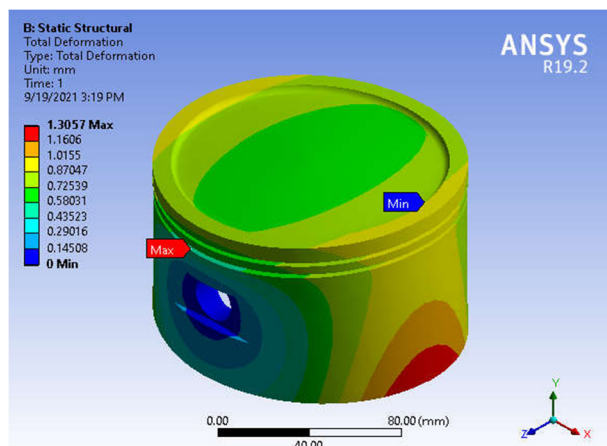
**Figure 1.1** – Temperature distribution in piston (Validation)



**Figure 1.2** Heat flux distribution in piston (Validation)



**Figure 1.3** thermal stress distributions in piston (Validation)



**Figure 1.4** Deformation in piston  
(Validation)

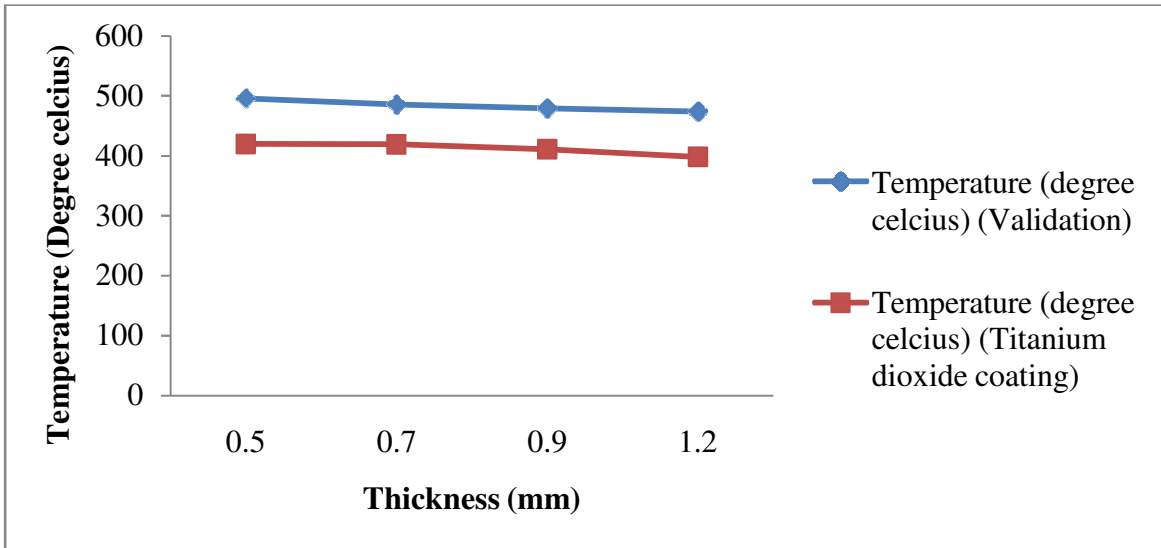
characteristics for temperature, thermal stress and deformation are presented below. The results have been compared with validation result of same parameter developed in present analysis operating under similar operating conditions to discuss the enhancement in temperature distribution of piston with different thickness of titanium dioxide.

### 1.5 Characteristics of Titanium dioxide coated piston:

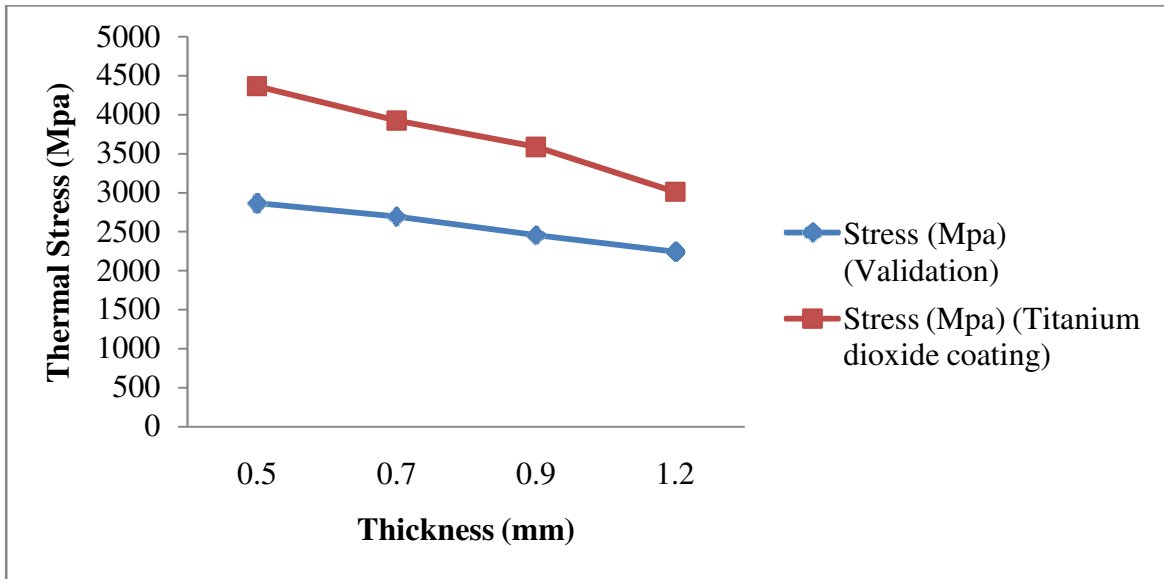
The effects of titanium dioxide coating with different thickness in piston and

**Table 1.2** Results obtained for titanium dioxide coated piston.

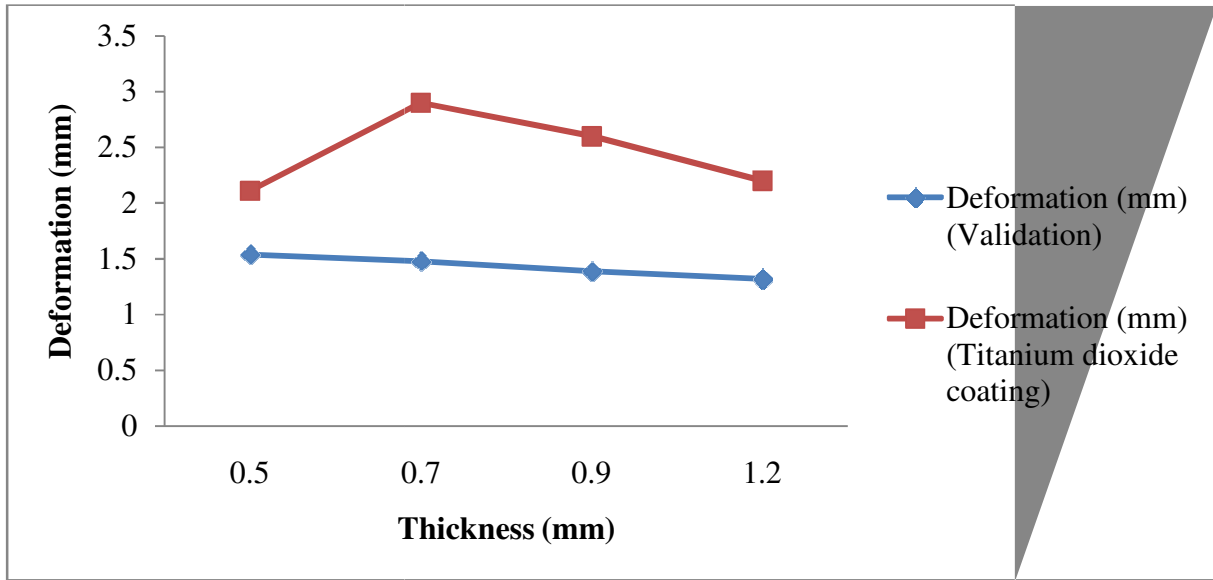
<b>Titanium dioxide coating</b>			
<b>Thickness (mm)</b>	<b>Temperature (degree celcius) (Titanium dioxide coating)</b>	<b>Stress (Mpa) (Titanium dioxide coating)</b>	<b>Deformation (mm) (Titanium dioxide coating)</b>
<b>0.5</b>	<b>420</b>	<b>4363.2</b>	<b>2.11</b>
<b>0.7</b>	<b>419.33</b>	<b>3925.6</b>	<b>2.9</b>
<b>0.9</b>	<b>411.25</b>	<b>3586.7</b>	<b>2.6</b>
<b>1.2</b>	<b>398.46</b>	<b>3010.9</b>	<b>2.2</b>



**Figure 1.5** – Comparison of temperature distribution of piston coated with titanium dioxide with respect to coating thickness

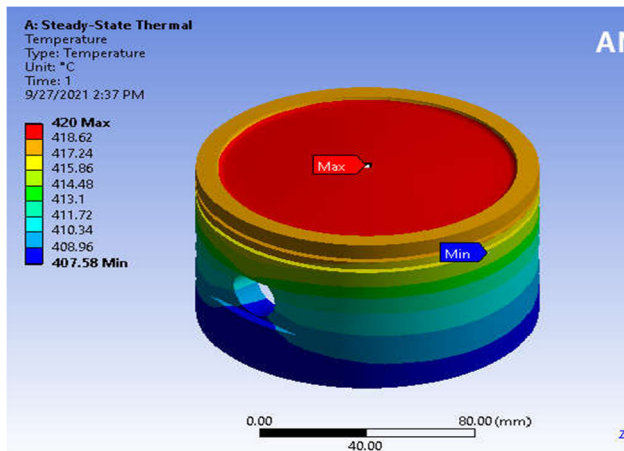


**Figure 1.6** – Comparison of thermal stress distribution of piston coated with titanium dioxide with respect to coating thickness

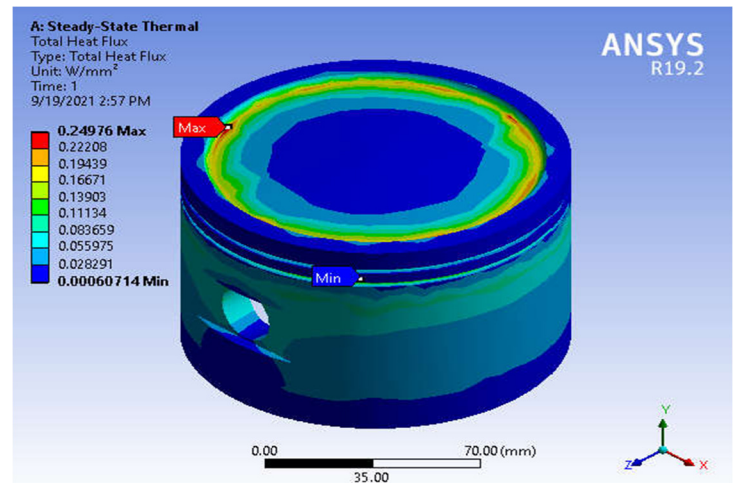


**Figure 1.7** – Comparison of deformation of piston coated with titanium dioxide with respect to coating thickness

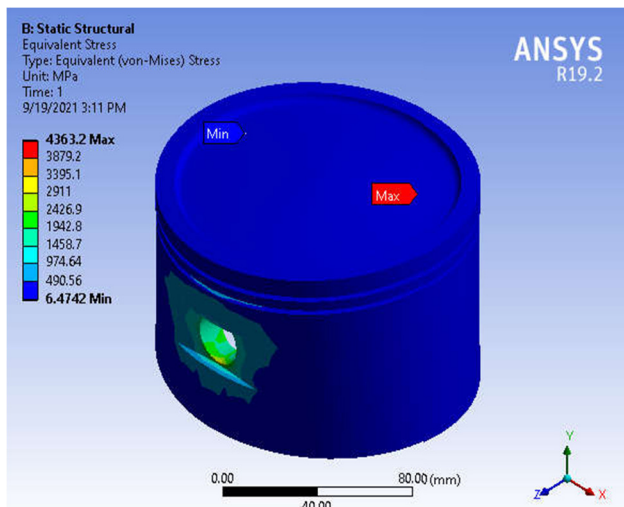
**1.6 Contour plot obtained for Titanium dioxide coated piston**



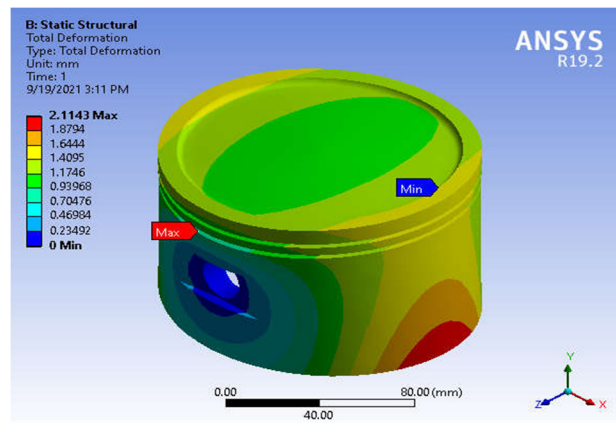
**Figure 1.8** – Temperature distribution of titanium dioxide coated piston.



**Figure 1.9** – Heat flux distribution of titanium dioxide coated piston.

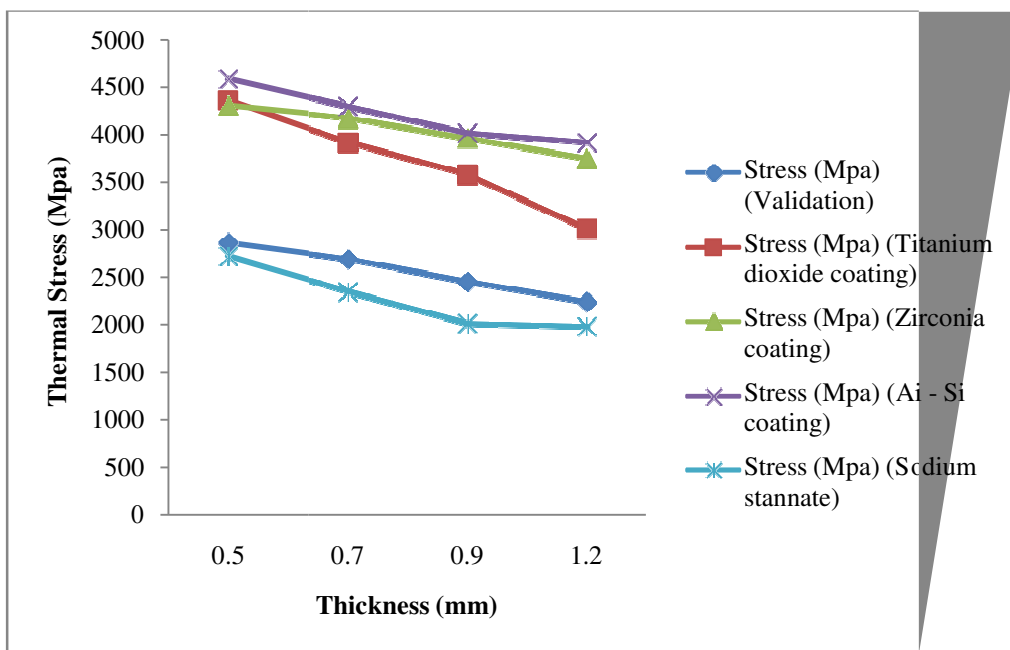


**Figure 1.10** – Thermal stress distribution of titanium dioxide coated piston.



**Figure 1.11** – Deformation of titanium dioxide coated piston.

**1.7 Overall comparison of coated piston with different thickness and materials:**



**Figure 1.12** – overall comparison of thermal stress with respect to thickness

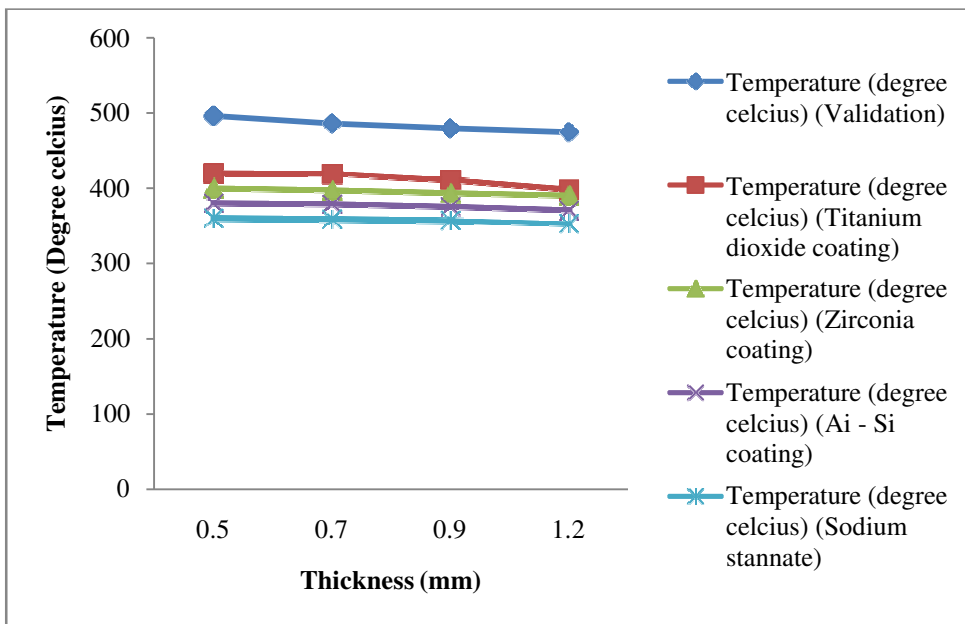


Figure 1.13 – overall comparison of temperature with respect to thickness

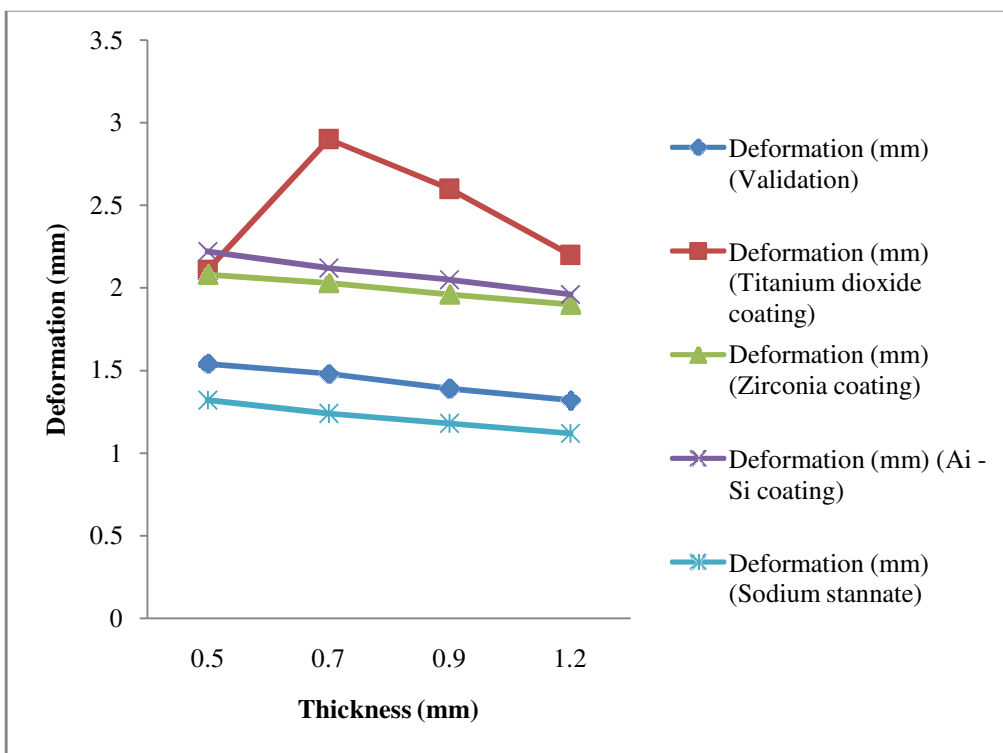


Figure 1.14 – overall comparison of deformation with respect to thickness



## Conclusion

- The simulation model was developed on ANSYS design modeler and analysis was done using the ANSYS software in steady state thermal and static structural 15.0 domain.
- Temperature distribution is the fundamental parameter in the performance of piston. The effect of temperature in crown of the piston will increase as the thickness of thermal barrier coating is decreased.
- In the study, the thickness of thermal barrier coating between 0.7 to 0.9 exhibits better convergence in each output parameter.
- The minimum temperature distribution is found in sodium stannate, thus existing material shows better temperature distribution in each proposed coating thickness.
- The effect of thermal stress is found to be less in sodium stannate in every coating thickness.
- Further, zirconium and titanium dioxide coating in piston also have better temperature distribution with optimum thermal stress and deformation.

- Deformation of sodium stannate coated piston exhibits minimum effect in each thickness.

## References

- [1]. [BowenJiao](#) et al. "Lubrication analysis of the piston ring of a two-stroke marine diesel engine considering thermal effects", [Engineering Failure Analysis](#) **Volume 129**, November 2021, 105659.
- [2]. [XiwenDeng](#) et al. "Controllable thermal state design method of flexible shapes of piston cooling galleries", [Applied Thermal Engineering](#), **Volume 191**, 5 June 2021, 116865
- [3]. [Hongshuai](#) et al. "High temperature tribological performance and thermal conductivity of thick Ti/Ti-DLC multilayer coatings with the application potential for Al alloy pistons", [Diamond and Related Materials](#), **Volume 117**, August 2021, 108466
- [4]. [F.Xia](#) et al. "Effect of thermal exposure on microstructure and high-temperature fatigue life of Al-Si piston alloys", [Journal of Materials Research and Technology](#), **Volume 9, Issue 6**, November–December 2020, Pages 12926-12935
- [5]. [G.Vidyasagar Reddy](#) et al. "Energy balance and emission analysis on diesel

- engine using different thermal barrier coated pistons”, [MATPRVolume 43, Part 1](#), 2021, Pages 646-654
- [6]. [ZhiminYao](#) et al. “Enhanced high-temperature thermal fatigue property of aluminum alloy piston with Nano PYSZ thermal barrier coatings”, [Journal of Alloys and Compounds, Volume 790](#), 25 June 2019, Pages 466-479
- [7]. [SabinoCaputo](#) et al. “Numerical and experimental investigation of a piston thermal barrier coating for an automotive diesel engine application”, [Applied Thermal Engineering, Volume 162](#), 5 November 2019, 114233
- [8]. [ZhiminYao](#) et al. “Microstructure and thermal analysis of APS nano PYSZ coated aluminum alloy piston”, [Journal of Alloys and Compounds, Volume 812](#), 5 January 2020, 152162
- [9]. [FujunHuang](#) et al. “Experimental investigation of operating characteristics and thermal balance of a miniature free-piston linear engine”, [Applied Thermal Engineering, Volume 178](#), September 2020, 115608
- [10]. [Rayapati](#) et al. “Thermal and structural analyses of an internal combustion engine piston with suitable different super alloys”, [MATPR, Volume 22, Part 4](#), 2020, Pages 2950-2956.